



ARS60-F1B00512

ARS60 SSI/Parallel

ABSOLUTE ENCODERS

SICK
Sensor Intelligence.

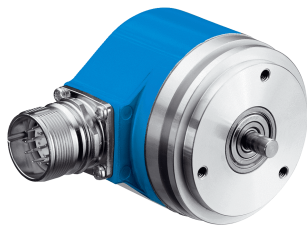

Illustration may differ



Ordering information

Type	Part no.
ARS60-F1B00512	1031570

Other models and accessories → www.sick.com/ARS60_SSI_Parallel

Detailed technical data

Performance

Number of steps per revolution (max. resolution)	512 (9 bit) Any number of steps from 00002 to 32768 possible. Always 5 characters in cleartext.
Error limits G	0.035° (binary number of steps) ¹⁾ 0.046° (non-binary number of steps)
Repeatability standard deviation σ_r	0.005° ²⁾

¹⁾ In accordance with DIN ISO 1319-1, position of the upper and lower error limit depends on the installation situation, specified value refers to a symmetrical position, i.e. deviation in upper and lower direction is the same.

²⁾ In accordance with DIN ISO 55350-13; 68.3% of the measured values are inside the specified area.

Interfaces

Communication interface	Parallel data world
Initialization time	80 ms ¹⁾
SSI	
Code type	Gray
Code sequence parameter adjustable	CW (clockwise) increasing when viewing the clockwise rotating shaft Increasing, when turning the shaft For clockwise rotation, looking in direction "A" (see dimensional drawing)

¹⁾ Valid positional data can be read once this time has elapsed.

Electrical data

Connection type	Male connector, M23, 21-pin, axial
Supply voltage	10 ... 32 V DC
Reverse polarity protection	✓
Short-circuit protection	✓
MTTFd: mean time to dangerous failure	300 years (EN ISO 13849-1) ¹⁾

¹⁾ This product is a standard product and does not constitute a safety component as defined in the Machinery Directive. Calculation based on nominal load of components, average ambient temperature 40°C, frequency of use 8760 h/a. All electronic failures are considered hazardous. For more information, see document no. 8015532.

Mechanical data

Mechanical design	Solid shaft, Servo flange
Shaft length	10 mm

Shaft diameter	6 mm
Weight	0.3 kg
Housing material	Aluminum die cast
Start up torque	0.25 Ncm
Operating torque	0.2 Ncm
Permissible Load capacity of shaft	20 N / radial 10 N / axial
Moment of inertia of the rotor	48 gcm ²
Bearing lifetime	3.6 x 10 ⁹ revolutions
Angular acceleration	≤ 500,000 rad/s ²

Ambient data

EMC	According to EN 61000-6-2 and EN 61000-6-3 ¹⁾
Enclosure rating	IP65, with mating connector fitted (according to IEC 60529)
Permissible relative humidity	90 % (condensation of the optical scanning not permitted)
Operating temperature range	-20 °C ... +85 °C
Storage temperature range	-40 °C ... +100 °C
Resistance to shocks	50 g, 11 ms (according to EN 60068-2-27)
Resistance to vibration	20 g, 10 Hz ... 2,000 Hz (according to EN 60068-2-6)

¹⁾ EMC according to the standards quoted is achieved if shielded cables are used.

Classifications

ECl@ss 5.0	27270502
ECl@ss 5.1.4	27270502
ECl@ss 6.0	27270590
ECl@ss 6.2	27270590
ECl@ss 7.0	27270502
ECl@ss 8.0	27270502
ECl@ss 8.1	27270502
ECl@ss 9.0	27270502
ETIM 5.0	EC001486
ETIM 6.0	EC001486
UNSPSC 16.0901	41112113

Dimensional drawing (Dimensions in mm (inch))

Servo flange, cable connection

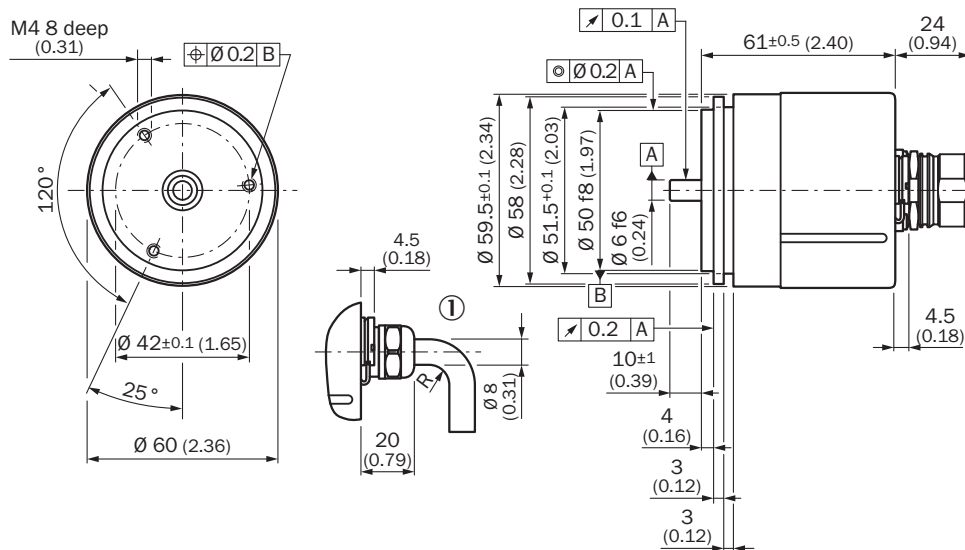

General tolerances according to DIN ISO 2768-mk

Ⓜ R = min. bending radius 40 mm

PIN assignment

• Allocation for encoder with 21-pin connector Single; Parallel Interface

PIN	Wire color by cable outlet	Binary	Gray	BCD	Description
1	Lilac	2 ⁰	G ₀	2 ⁰ v.10 ⁰	Data lines, outputs
2	White/brown	2 ¹	G ₁	2 ¹ v.10 ⁰	
3	White/green	2 ²	G ₂	2 ² v.10 ⁰	
4	White/yellow	2 ³	G ₃	2 ³ v.10 ⁰	
5	White/gray	2 ⁴	G ₄	2 ⁴ v.10 ⁰	
6	White/pink	2 ⁵	G ₅	2 ⁵ v.10 ⁰	
7	White/blue	2 ⁶	G ₆	2 ⁶ v.10 ⁰	
8	White/red	2 ⁷	G ₇	2 ⁷ v.10 ⁰	
9	White/black	2 ⁸	G ₈	2 ⁸ v.10 ⁰	
10	Brown/green	2 ⁹	G ₉	2 ⁹ v.10 ⁰	
11	Brown/yellow	2 ¹⁰	G ₁₀	2 ¹⁰ v.10 ⁰	
12	Brown/gray	2 ¹¹	G ₁₁	2 ¹¹ v.10 ⁰	
13	Brown/pink	2 ¹²	G ₁₂	2 ¹² v.10 ⁰	
14	Brown/blue	2 ¹³	G ₁₃	2 ¹³ v.10 ⁰	
15	Brown/red	2 ¹⁴	G ₁₄	2 ¹⁴ v.10 ⁰	
16	Green	Parity	Parity	Parity	
17	Pink	Store ₋	Store ₋	Store ₋	
18	Yellow	Enable ₋	Enable ₋	Enable ₋	
19	Brown	V/R ₋	V/R ₋	V/R ₋	
1)	Gray	SET	SET	SET	
20	Blue	GND	GND	GND	
21	Red	U _s	U _s	U _s	
Housing		Screen	Screen	Screen	



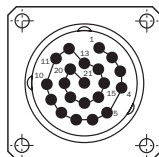



*) Set line only possible with a cable outlet.
 U_s Supply voltage to the encoder (before commissioning, note must be taken of the type label of the encoder).
 GND Zero volt connection to the encoder; electrically isolated from the housing. The voltage referred to GND is U_s.
 V/R₋ Forward/reverse: this input programs the counting direction of the encoder. If not connected, this input is +high-. If the encoder shaft, as viewed on the drive shaft, rotates in the clockwise direction, it counts in an increasing sequence. If it should count upwards when the shaft rotates in the anti-clockwise direction, this connection must be connected permanently to -low- level (zero volts).
 Enable₋ This input activates the data output driver when a -low- level is applied. If not connected, this input is -low-. In the case of a +high- level, the outputs are in the tristate mode.
 Store₋ This input stores the encoder data in Gray code when a -low- level is applied. This avoids a read error if the output data is requested in binary code. If this input is -low-, the data at the encoder output is stable, irrespective of whether the input shaft rotates. If not switched, this input is +high-.
 Parity This output supplies a +high- level when the binary checksum of the data bits is even.
 SET This input serves to set the zero electronically. If the SET line is connected to U_s for more than 100 ms, the mechanical position corresponds to the value 0.



View of the connector M23 fitted to the encoder body Single, Parallel

Recommended accessories

Other models and accessories → www.sick.com/ARS60_SSI_Parallel

	Brief description	Type	Part no.
Other mounting accessories			
	Mounting bell for encoder with servo flange, 50 mm spigot, mounting kit included	BEF-MG-50	5312987
	Half-shell servo clamps (2 pcs.) for servo flanges with a 50 mm centering hub	BEF-WG-SF050	2029165
	Servo clamps, large, for servo flanges (clamps, eccentric fastener), 3 pcs., without mounting material, without mounting hardware	BEF-WK-SF	2029166
Shaft adaptation			
	Bellows coupling, shaft diameter 6 mm / 6 mm, maximum shaft offset: radial ± 0.25 mm, axial ± 0.4 mm, angular $\pm 4^\circ$; max. speed 10,000 rpm, -30°C to $+120^\circ\text{C}$, max. torque 80 Ncm; material: stainless steel bellows, aluminum hub	KUP-0606-B	5312981
	Bellows coupling, shaft diameter 6 mm / 10 mm, maximum shaft offset: radial ± 0.25 mm, axial ± 0.4 mm, angular $\pm 4^\circ$; max. speed 10,000 rpm, -30°C to $+120^\circ\text{C}$, max. torque 80 Ncm; material: stainless steel bellows, aluminum hub	KUP-0610-B	5312982
	Spring washer coupling, shaft diameter 6 mm / 10 mm, Maximum shaft offset: radial ± 0.3 mm, axial ± 0.4 mm, angular $\pm 2.5^\circ$; max. speed 12,000 rpm, -10° to $+80^\circ\text{C}$, max. torque 60 Ncm; material: aluminum flange, glass fiber-reinforced polyamide membrane and hardened steel coupling pin	KUP-0610-F	5312985
Plug connectors and cables			
	Head A: cable Head B: Flying leads Cable: parallel, PUR, halogen-free, shielded	LTG-2622-MW	6027532
	Head A: female connector, M23, 21-pin, straight Head B: Flying leads Cable: parallel, PUR, halogen-free, shielded, 3 m	DOL-2321-G03MPA4	2029219
	Head A: female connector, M23, 21-pin, straight Head B: Flying leads Cable: parallel, PUR, halogen-free, shielded, 5 m	DOL-2321-G05MPA4	2029220
	Head A: female connector, M23, 21-pin, straight Head B: Flying leads Cable: parallel, PUR, halogen-free, shielded, 10 m	DOL-2321-G10MPA4	2029221
	Head A: female connector, M23, 21-pin, straight Head B: Flying leads Cable: parallel, PUR, halogen-free, shielded, 1.5 m	DOL-2321-G1M5PA4	2029218
	Head A: female connector, M23, 21-pin, straight Head B: Flying leads Cable: parallel, PUR, halogen-free, shielded, 20 m	DOL-2321-G20MPA4	2029222
	Head A: female connector, M23, 21-pin, straight Head B: - Cable: SSI, shielded	DOS-2321-G	6027539

SICK AT A GLANCE

SICK is one of the leading manufacturers of intelligent sensors and sensor solutions for industrial applications. A unique range of products and services creates the perfect basis for controlling processes securely and efficiently, protecting individuals from accidents and preventing damage to the environment.

We have extensive experience in a wide range of industries and understand their processes and requirements. With intelligent sensors, we can deliver exactly what our customers need. In application centers in Europe, Asia and North America, system solutions are tested and optimized in accordance with customer specifications. All this makes us a reliable supplier and development partner.

Comprehensive services complete our offering: SICK LifeTime Services provide support throughout the machine life cycle and ensure safety and productivity.

For us, that is “Sensor Intelligence.”

WORLDWIDE PRESENCE:

Contacts and other locations –www.sick.com